

Introduction

This contribution has been prepared as a new framework for the VTC/VT draft standard. This new framework addresses a number of key concerns and issues that were not addressed in the original draft. Among these are:

1. In-Service as well as out-of-service performance specifications.
2. The capability to accommodate new digital performance parameters as well as traditional analog performance parameters. This will allow the VTC/VT sub-working group to smoothly integrate fundamentally different performance parameters into the draft standard.
3. A methodology for incorporating performance parameters into the draft standard to assure that the objective performance correlates with the user-perceived subjective quality.

This contribution is only a framework. No performance parameters have been included at this stage. Performance parameters can easily be added once the VTC/VT sub-working group agrees on the basic framework for the draft standard and the methodology for incorporating performance parameters into the draft standard.

AMERICAN NATIONAL STANDARD

FOR TELECOMMUNICATIONS -

DIGITAL TRANSPORT OF VIDEO

TELECONFERENCING / VIDEO

TELEPHONY SIGNALS -

SYSTEM M-NTSC ANALOG

INTERFACE SPECIFICATIONS AND

PERFORMANCE PARAMETERS

FOREWORD

(This foreword is not part of the American National Standard).

This standard addresses the performance characteristics of **Video Teleconferencing/Video Telephony (VTC/VT)** service channels employing digital transport. The performance parameters are expressed as a function of a **single coding** between the end points of a transmission service channel. Each transmission service channel may be used by itself or may become part of a larger transmission channel. Performance definitions and measurement methods are provided if appropriate. Interface definitions are provided to facilitate compatibility between end users, service providers, and carriers.

This standard is intended to provide a means of assuring and maintaining transmission performance quality between defined transmission service channel interfaces.

Video signals originated or transmitted in accordance with standards other than system M-NTSC may not necessarily be compatible with the specifications of this standard.

Suggestions for improvement of this standard are welcome. They should be sent to The Exchange Carriers Standards Association - Committee T1 Secretariat, Suite 200, 5430 Grosvenor Lane, Bethesda, MD 20814-4505.

This standard was processed and approved for submittal to ANSI by Accredited Standards Committee T1 - Telecommunications. Committee approval of this standard does not necessarily imply that all committee members voted for its approval. At the time it approved this standard, Committee T1 had the following officers and members:

I. N. Knight, Chairman
A. K. Reilly, Vice-Chairman
O. J. Gusella, Jr., Secretary

Organization Represented

Name of Representative

EXCHANGE CARRIERS

- Alltel Service Corporation
- Ameritech Services, Inc.
- Bell Atlantic
- Bell Communications Research.....
- BellSouth Services
- Centel Corporation.....
- Contel Service Corporation.....
- Exchange Carriers Standards Association
- GTE SC/Telephone Operations.....
- National Telephone Cooperative Association
- NYNEX
- Pacific Bell
- Pureto Rico Telephone Company.....
- Southern New England Telephone.....
- Southwestern Bell Telephone Company
- Telephone & Data Systems.....
- United States Telephone Association.....
- United Telephone System, Inc.....
- U S WEST.....

INTEREXCHANGE CARRIERS

- AT&T Communications
- CNCP Telecommunications
- Communications Transmission, Inc.....
- COMSAT.....
- Contel ASC
- MCI Telecommunications Corp.
- Siemens Communication Systems, Inc.....
- Stromberg Carlson Corporation
- Telco Systems, Inc.
- Telecom Canada
- Telecommunications Techniques Corporation
- Telex Computer Products, Inc.
- TELINQ Systems, Inc.....
- TIMEPLEX, Inc.....
- Tymnet, Inc./McDonnell Douglas Corporation
- Unisys
- US Sprint.....
- U. S. Telecommunications Suppliers Association.....
- Verilink Corporation
- Video Conferencing Systems, Inc.
- Western Union Telegraph Company

MANUFACTURERS

ADC Telecommunications, Inc.
Alcatel, NA
AMP Inc.
AT&T Technologies
Digital Equipment Corporation
DSC Communications Corporation.....
ECI Telecom Inc.
Ericsson, Inc.
Fortel Corporation
Fujitsu America, Inc.
General DataComm Industries
GTE Communication Systems Corporation
Harris Corporation.....
Hekimian Laboratories, Inc.....
Hewlett Packard
Honeywell Bull.....
IBM Corporation
Integrated Technology, Inc.....
LICOM, Inc.....
M/A COM Corporation.....
Mitel Corporation.....
Motorola, Inc.
Myriad Concepts, Inc.
NCR Corporation
NEC America, Inc.
Northern Telecom Inc.
Phoenix Microsystems, Inc.
Plantronics, Inc.
Racal Milgo, Inc.....
Rockwell International Corporation

GENERAL INTEREST

American Broadcasting Company.....
Ashford Associates
Association of Telemessaging Services International, Inc.
BDM Corporation, The
Carter Hawley Hale Information Services
CBS Broadcasting Group CBS, Inc.
Creative Communications Consulting.....
Defense Communications Agency
Federal Express Corporation
General Services Administration.....
Martin Marietta Information and Communications Systems.....
National Broadcasting Company
National Bureau of Standards

National Communications System.....
National Telecommunications and Information Administration,
Institute for Telecommunication Sciences (NTIA/ITS).....
OMNICOM, Inc.....
Rural Electrification Administration.....
Utilities Telecommunications Council

At the time it approved this standard, the Technical Subcommittee for Performance T1Q1 had the following officers and members:

Godfrey Williams, Chair
R. E. Jensen, Vice-Chair
R. B. Waller, Secretary

Work Group T1Q1.5 Wideband Program, which developed this standard had the following officers and participants:

Howard Meiseles, Chair
Steve Gloeckle, Vice-Chair
Warner Johnston, Secretary

List of members will be added later.

Participants

John Bekerich	David Bennett	Lyle Bradt
Ralph Brainard	Fred Camarillo	Hugh Chen
Gerard Clement	Bill Coufal	Tom Garcia
Steve Gloeckle	Ronald Gnidziejko	David Hanna
Hal Holton	Takunori Ito	James Jamison
Granger Kelley	Maurice Peronnet	Joe Presti
Edmund Quincy	Richard Quinn	Gary Rekstad
Michael Rossman	John Roth	Richard Schaphorst
Carl Sederquist	Alice Smith	Marvin Straus
Elmer Swope	C. F. Taylor	Bob Traill
Evert Turvey	Ed Underwood	Daniel Wirth
M. N. Woinsky	Stephen Wolf	William Zon

Editorial Committee of the Video Conferencing/Video Telephony Standard

Daniel Wirth, Chair
Gerard Clement
Bill Coufal
Granger Kelley
Edmund Quincy
Richard Quinn
Richard Schaphorst
Marvin Straus
C. F. Taylor
Stephen Wolf

TABLE OF CONTENTS

Foreward.....	ii
List of Figures.....	ix
List of Tables.....	xi
1 Scope, Purpose, and Application.....	1
1.1 Scope.....	1
1.2 Purpose.....	2
1.3 Application.....	2
2 References and Related Standards.....	2
2.1 American National Standards.....	2
2.2 Other Related National Standards.....	2
2.3 Other Related Standards.....	2
2.4 Other Related Publications.....	2
3 Definitions.....	2
3.1 Special Word/Phrase Usage.....	2
3.2 Video Signals.....	4
4 Baseband VTC/VT Interface Specifications.....	7
4.1 Video Signal Electrical Interface Specifications.....	7
4.2 Video Signal.....	8
4.3 Audio Signal Electrical Interface Specifications.....	11
4.4 Audio Signal.....	14
5 Out-of-Service Baseband VTC/VT Performance Specification.....	16
5.1 Video Performance.....	16
5.2 Audio Performance.....	19
5.3 Audio-Visual Performance Measures.....	20
6 In-Service Baseband VTC/VT Performance Specification.....	20
6.1 Video Performance.....	21
6.2 Audio Performance.....	22
6.3 Audio-Visual Performance Measures.....	23

Appendix.....	24
Glossary.....	32
Items Under Study.....	32

List of Figures

Figure 1	Digital Transmission Service Channel with Interfaces	1
Figure 2	Standard Video Signal General Waveform Terminology	5
Figure 3	IRE Unit Scale - Video.....	5
Figure 4	Composite Test Signal - Video.....	6
Figure 5	Impedance Reference - Unbalanced to Ground - Video	7
Figure 6	Impedance Reference - Balanced to Ground - Audio	12
Figure 7	Nonsymmetrical Test Waveform - Audio	15
Figure 8	Out-of-Service Testing Block Diagram	16
Figure 9	In-Service Testing Block Diagram	21
Figure A1	Approach Used To Evaluate Objective Quality Estimation Methods	26
Figure A2	Information Content of Test Scenes.....	27
Figure A3	Block Diagram of Subjective Combiners	30

List of Tables

Table 1 Video Performance Specifications for Several Applications 18

Table 2 Audio Performance Specifications for Several Applications..... 20

American National Standard for Telecommunications - Digital Transport of Video Teleconferencing / Video Telephony Signals -

System M-NTSC Analog Interface Specifications and Performance Parameters

1 Scope, Purpose, and Application.

1.1 Scope.

This standard covers analog interface specifications in the system M-NTSC format and performance parameters of Video Teleconferencing/Video Telephony (VTC/VT) transmission service channels employing digital transport. VTC/VT signals created or transmitted in accordance with other standards or formats may not necessarily be compatible with the specifications of this standard.

This standard specifies the performance of transmission service channels employing digital transport provided to convey VTC/VT signals and their associated audio signals only. Performance values are for a single coding (refer to Figure 1) and are allocated by grades of service. Performance definitions and measurement methods are provided if appropriate. Interface specifications are provided to facilitate compatibility between end users, service providers, and carriers.

The performance characteristics identified within this standard apply to the transmission quality between the defined interfaces. Those interfaces are between VTC/VT transmission service providers and end users. This standard defines neither the interconnection nor the performance characteristics of specific apparatus or equipment.

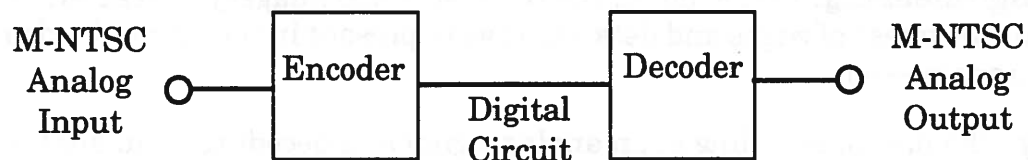

Figure 1 Digital Transmission Service Channel with Interfaces

1.2 Purpose.

The purpose of this standard is to assure the uniform application of standard values of transmission parameters for VTC/VT signals transported digitally by portions of the telecommunications network. It is intended to provide a common understanding by manufacturers, carriers, and their customers.

1.3 Application.

The primary applications of this standard are for specifying and evaluating the performance of a VTC/VT transmission service employing digital transport provided by common carriers. This service is used to transport the audio and video portions of the VTC/VT signals.

2 References and Related Standards.

2.1 American National Standards.

This standard is intended to be used in conjunction with the following American National Standards.

2.2 Other Related National Standards.

2.3 Other Related Standards.

2.4 Other Related Publications.

3 Definitions.

3.1 Special Word/Phrase Usage.

average picture level (APL): The average level of the picture signal during active scanning time integrated over a frame period and defined as a percentage of the range between blanking and reference white.

blocking: Distortion in the received video imagery characterized by rectangular or checkerboard patterns that were not present in the original video imagery before transmission.

blurring/smearing: Distortion in the received video imagery characterized by reduced sharpness of edges and detail that were present in the original video imagery before transmission.

coding: The digital encoding of an analog signal and decoding to an analog signal.

digital transport: A portion of the telecommunication network using digital methods for the transmission of signals from one point to another to complete a transmission service channel. A transmission service channel may have one or more

digital transport portion(s).

edge busyness: The deterioration of motion video such that the outlines of moving objects are displayed with randomly varying activity.

frame cuts: Video imagery where adjacent frames are not highly correlated.

image persistence: The appearance of earlier faded video frames of a moving and/or changing object within the current frame. (e.g., an object that was erased continues to appear in the received video imagery.)

jerkiness: The original smooth and continuous motion is perceived as a series of distinct 'snapshots'.

longitudinally balanced: A circuit is perfectly longitudinally balanced if disturbing common mode voltages (V_c) result in zero differential voltage (V_d). For circuits that are not perfectly longitudinally balanced, the degree of longitudinal balance is reported in dB using:

$$\text{Longitudinal Balance} = 20 \cdot \log_{10} \left(\frac{V_c}{V_d} \right)$$

mosquito noise: The noise generated by the block processing of moving objects that gives the appearance of false small moving objects (e.g., a mosquito flying around a person's head and shoulders).

motion response degradation: The deterioration of motion video such that the received video imagery has suffered a loss of spatio-temporal resolution.

motion video: Video imagery that conveys movement.

spatial application: For spatial applications, emphasis is placed on attaining high spatial resolution, possibly at the expense of reduced temporal positioning accuracy (or increased jerkiness). This application group is concerned with the ability to read small characters and see fine detail in still video and/or motion video which contains a very limited amount of motion.

spatial performance: A measure of the ability of a video transmission system to accurately reproduce still scenes.

still video: Video imagery that does not convey movement.

temporal application: For temporal applications, emphasis is placed on temporal positioning accuracy (or reduced jerkiness), possibly at the expense of reduced spatial resolution. This application group is concerned with the ability to accurately distinguish such items as facial expressions and lip movements in face to face and/or conference room settings.

temporal performance: A measure of the ability of a video transmission system to

accurately reproduce moving scenes.

transmission service channel: A transmission service channel is the one-way transmission path between two designated points (analog in, analog out).

video: (1) The visually displayed images of video teleconferencing/video telephony. (2) Of or pertaining to the visually displayed images of video teleconferencing/video telephony.

video frame: A single frame of video composed of two interlaced fields.

video imagery: A contiguous sequence of video frames.

video teleconferencing/video telephony motion artifacts: In a video teleconferencing/video telephony system, deteriorations of motion video due to image data compression that are observable by the viewer.

video teleconferencing/video telephony service (VTC/VT): The transmission of video signals capable of portraying motion and the accompanying audio signal(s) between two or more locations using digital transmission facilities. A typical example of this service is video teleconferencing between groups of personnel located at two or more locations.

3.2 Video Signals.

3.2.1 Video Signal Description. The waveform terminology used throughout the standard is in accordance with Figure 2, where the standard video signal waveform terminology is shown and measured in IRE units as shown in Figure 3.

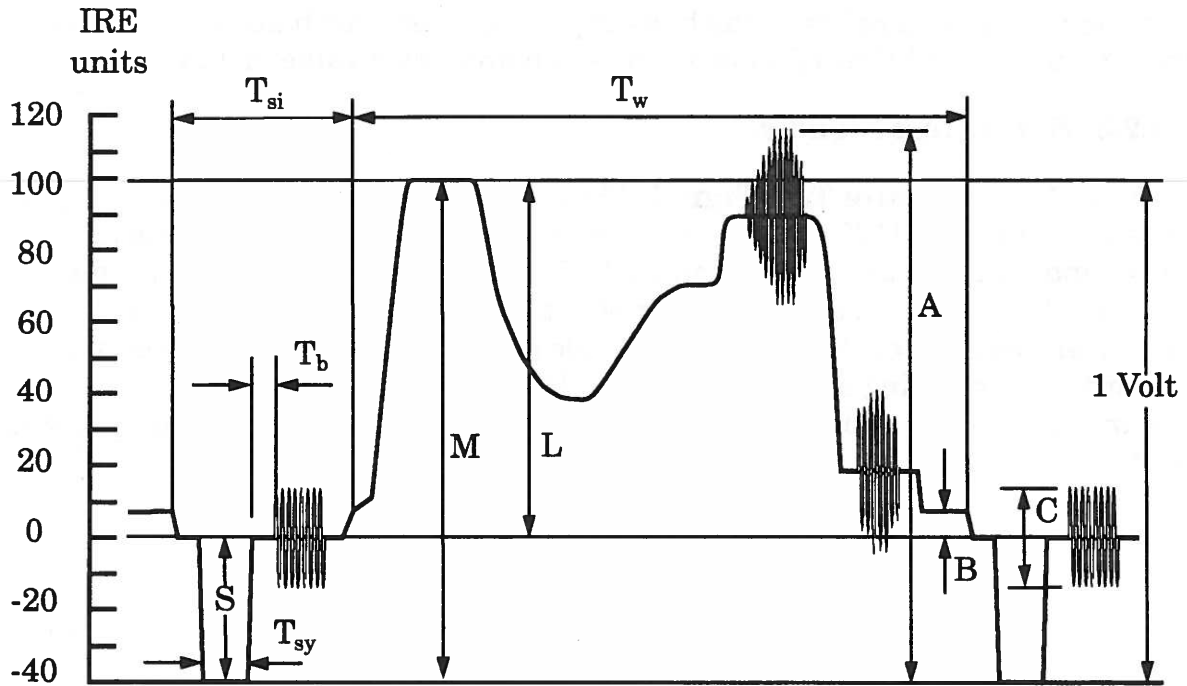

Waveform Terminology

- A: The peak-to-peak amplitude of the composite color video signal
- B: The difference between black level and blanking level (set-up)
- C: The peak-to-peak amplitude of the color burst
- L: Luminance signal - nominal value
- M: Monochrome video signal peak-to-peak amplitude ($M=L+S$)
- S: Synchronizing signal amplitude
- T_b : Duration of breezeway
- T_{si} : Duration of line blanking period
- T_{sy} : Duration of line synchronizing pulse
- T_w : Duration of active line period

Figure 2 Standard Video Signal General Waveform Terminology

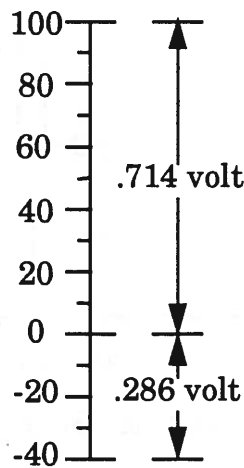

(For a 1 V P-P composite signal)

Figure 3 IRE Unit Scale - Video

3.2.2 Test Signal Description. Reference to time (T) in the description of the following test signals refers to the half-amplitude pulse-width duration and not the rise time nor the fall time of a pulse transition and has a value of 125 nanoseconds.

3.2.3 Static Test Signals.

3.2.3.1 Composite Test Signal. The composite test signal shown in Figure 4 consists of a line bar (125 nanosecond rise time and fall time), a 2T pulse (250 nanosecond half-amplitude duration), a 12.5T (1.5625 microseconds half-amplitude duration) chrominance pulse, and a 5-riser staircase signal modulated by the color sub-carrier having a peak-to-peak amplitude of 40 IRE units superimposed upon standard synchronizing and blanking signals. Reference A and B are the measurement points utilized in the measurement of insertion gain and insertion-gain variation.

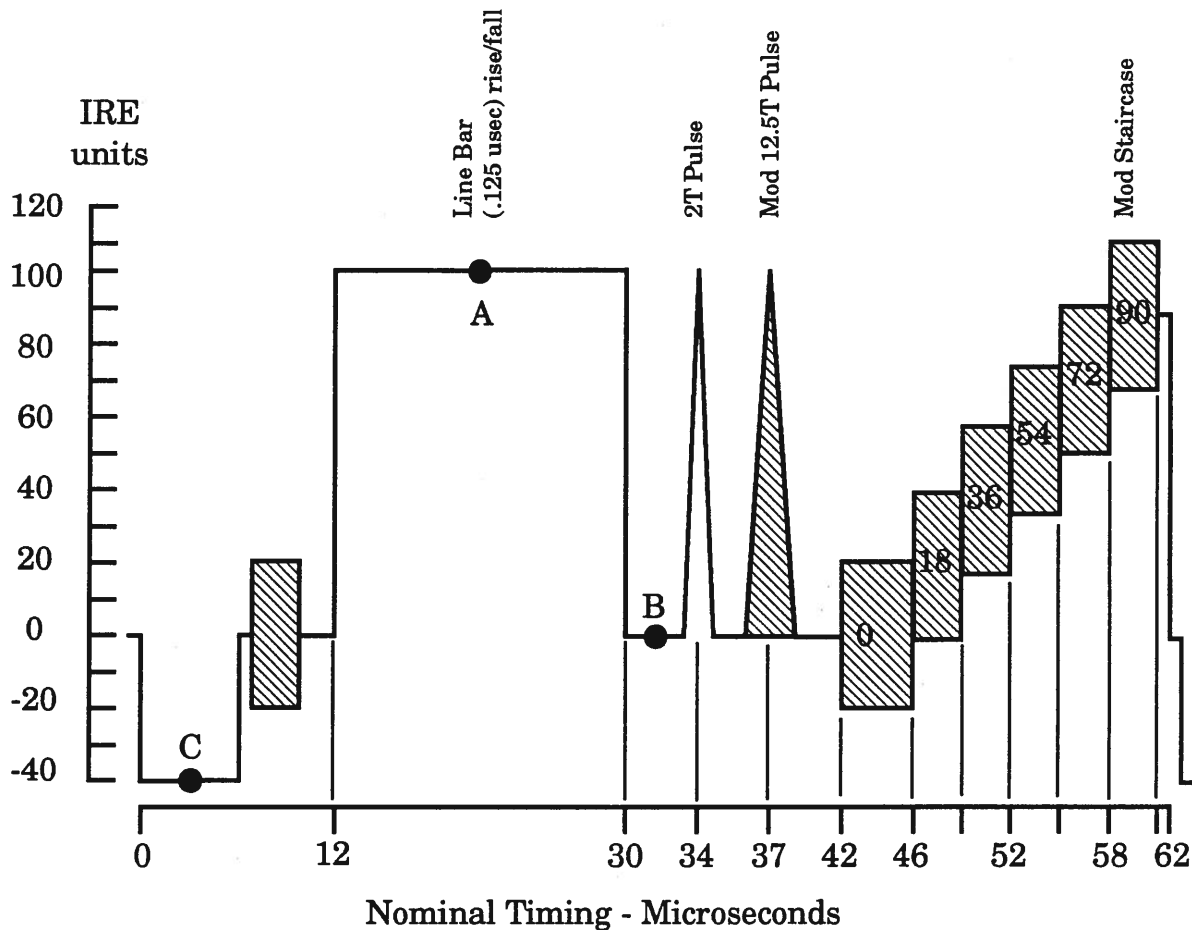

Figure 4 Composite Test Signal - Video

4 Baseband VTC/VT Interface Specifications.

4.1 Video Signal Electrical Interface Specifications.

4.1.1 Impedance.

4.1.1.1 Source Impedance.

4.1.1.1.1 Definition. The video source impedance of a transmission service channel, Z_s shown in Figure 5, is the impedance presented to the input terminals of a transmission service channel or other video baseband input point by the output terminals of the signal source. Proper source impedance is required for service channel evaluation.

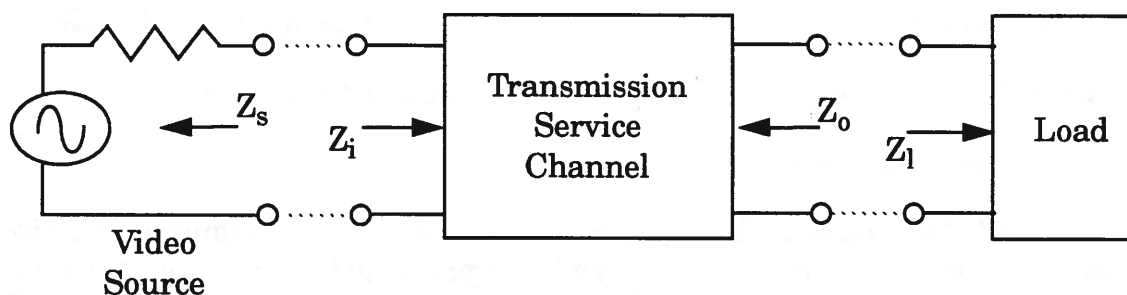

Figure 5 Impedance Reference - Unbalanced to Ground - Video

4.1.1.1.2 Standard Value. The standard value shall be 75 ohms, unbalanced to ground, with a return loss of at least x dB over the frequency range of 20 Hz - 4.2 MHz.

4.1.1.1.3 Method of Measurement. The impedance is measured by using impedance measurement equipment and the return loss is reported in dB using the following formula:

$$\text{Return Loss} = 20 \cdot \log_{10} \left| \frac{Z + Z_m}{Z - Z_m} \right|$$

Where

Z = specified standard impedance

Z_m = measured impedance

Alternately, the return loss may be measured using a return loss bridge.

4.1.1.2 Input Impedance.

4.1.1.2.1 Definition. The video input impedance of a transmission service channel, Z_i shown in Figure 5, is the impedance presented by the input terminals of a transmission service channel or other video baseband input point.

4.1.1.2.2 Standard Value. The standard value shall be 75 ohms, unbalanced to ground, with a return loss of at least x dB over the frequency range of 20 Hz - 4.2 MHz.

4.1.1.2.3 Method of Measurement. See section 4.1.1.1.3 on page 7.

4.1.1.3 Output Impedance.

4.1.1.3.1 Definition. The video output impedance of a transmission service channel, Z_o shown in Figure 5, is the impedance presented by the output terminals of a transmission service channel or other baseband output point.

4.1.1.3.2 Value. The standard value shall be 75 ohms, unbalanced to ground, with a return loss of at least x dB over the frequency range of 20 Hz - 4.2 MHz.

4.1.1.3.3 Method of Measurement. See section 4.1.1.1.3 on page 7.

4.1.1.4 Load Impedance.

4.1.1.4.1 Definition. The video load impedance of a transmission service channel, Z_l shown in Figure 5, is the impedance presented by the input terminals of the device which will terminate the video baseband output of the transmission service channel. Proper load impedance is required for service channel evaluation.

4.1.1.4.2 Standard Value. The standard value shall be 75 ohms, unbalanced to ground, with a return loss of at least x dB over the frequency range of 20 Hz - 4.2 MHz.

4.1.1.4.3 Method of Measurement. See section 4.1.1.1.3 on page 7.

4.2 Video Signal.

4.2.1 Polarity of the Picture Signal.

4.2.1.1 Definition. The polarity of the picture signal of a transmission service channel is the sense of the potential of a portion of the signal representing a dark area of a scene relative to the potential of a portion of the signal representing a light area. Polarity is stated as "black positive" or "black negative". It is the polarity presented to the transmission service channel input terminals and presented by the transmission service channel output terminals.

4.2.1.2 Standard Value. The polarity of the picture signal is "black negative".

4.2.1.3 Method of Measurement. The polarity of the picture signal is

determined by use of an oscilloscope or waveform monitor of known deflection polarity.

4.2.2 Input Signal.

4.2.2.1 Signal Level.

4.2.2.1.1 Definition. The input signal level of a transmission service channel is the difference in voltage between sync tip (-40 IRE units) and reference white (100 IRE units) of a composite video signal presented to the video baseband input terminals. It is expressed in volts.

4.2.2.1.2 Standard Value. The standard value shall be a nominal 1 volt peak-to-peak difference between sync tip and reference white, 140 IRE units (see Figure 2 on page 5 and Figure 3 on page 5).

4.2.2.1.3 Method of Measurement. The input signal level is measured by means of a properly calibrated and terminated oscilloscope or waveform monitor.

4.2.2.2 Time Base Error.

4.2.2.2.1 Definition. Time base error is defined as the difference between the instantaneous time base (which is the time between the 50% value of the leading edges of two successive horizontal sync pulses) and the time base averaged over one frame. The time base error defined here is typically that which is generated by a video tape machine.

4.2.2.2.2 Standard Value. The absolute value of the largest time base error shall be less than x microseconds.

4.2.2.2.3 Method of Measurement. The time base error is measured by applying the video signal to a time base error reading instrument.

4.2.2.3 Unweighted Signal to Noise Ratio.

4.2.2.3.1 Definition. The unweighted signal-to-noise ratio of the input signal is the ratio of the peak-to-peak luminance signal, blanking to reference white (nominally 0.714 volt = 100 IRE units), to the rms band limited noise level. The noise may be mixed random and quantizing noise. Synchronizing signals are not included in the signal measurement. It is measured at the output of the video source.

4.2.2.3.2 Standard Value. The standard value is greater than x dB. In addition, the input of the transmission service channel must tolerate noise that is out of band and could have voltage spikes several times that of the band limited noise.

4.2.2.3.3 Method of Measurement. The input signal of a transmission service channel is connected to the input of a rms reading meter through standard low pass filter x and high pass filter y. The video S/N is measured using a video line that

is at a constant IRE level. The readings are averaged over a .4 second interval where synchronizing signals are excluded. This measurement is equivalent to the unweighted version of the signal to noise ratio measurement commonly known as NTC 7 3.16.

4.2.3 Output Signal.

4.2.3.1 Signal Level.

4.2.3.1.1 Definition. The output signal level of a transmission service channel is the difference in voltage between sync tip and reference white of a composite test signal presented by the video baseband output terminals. It is expressed in volts peak-to-peak.

4.2.3.1.2 Standard Value. The standard value shall be a nominal 1 volt peak-to-peak difference between sync tip and reference white, 140 IRE units (see Figure 2 on page 5 and Figure 3 on page 5).

4.2.3.1.3 Method of Measurement. Apply the composite test signal shown in Figure 4 on page 6 to the transmission service channel input. The output signal level is measured by means of a properly calibrated and terminated oscilloscope or waveform monitor.

4.2.3.2 Time Base Error.

4.2.3.2.1 Definition. Time base error is defined as the difference between the instantaneous time base (which is the time between the 50% value of the leading edges of two successive horizontal sync pulses) and the time base averaged over one frame.

4.2.3.2.2 Standard Value. The absolute value of the largest time base error shall be less than x microseconds.

4.2.3.2.3 Method of Measurement. See section 4.2.2.2.3 on page 9.

4.2.3.3 Non-Useful DC Component.

4.2.3.3.1 Definition. The non-useful DC component of the output signal is any DC component which is unrelated to the output signal. It will be present only as a result of the transmission equipment.

4.2.3.3.2 Standard Value. The standard value is $\leq x$ IRE units across a standard termination (75 ohms).

4.2.3.3.3 Method of Measurement. The non-useful DC component of the output signal is measured with a properly terminated DC coupled waveform monitor (WFM). Apply the composite test signal shown in Figure 4 on page 6 to the input terminals of the transmission service channel. With the WFM in a non-clamping

mode, measure the signal at the output of the transmission service channel. Terminate the transmission service channel input in 75 ohm and measure the new position of the trace. The non-useful DC component is the difference in IRE units between the 0 and new trace position.

4.2.4 Input to Output Video Relationships.

4.2.4.1 Active Video Area.

4.2.4.1.1 Definition. The active video area is the portion of the input video signal that is not blanked by the transmission service channel.

4.2.4.1.2 Standard Value. The active video area shall be from x_1 usec to x_2 usec of video lines y_1 through y_2 inclusive.

4.2.4.1.3 Method of Measurement. Inject a video signal into the input of the transmission service channel with a marker at each of the following 4 locations: 1.) line y_1 , x_1 usec, 2.) line y_1 , x_2 usec, 3.) line y_2 , x_1 usec, 4.) line y_2 , x_2 usec. Check the output of the transmission service channel for the presence of the markers. If all 4 markers are observed, then the entire active video area is being passed by the transmission service channel.

4.2.4.2 Active Video Shift.

4.2.4.2.1 Definition. The active video shift is the amount of vertical and horizontal shift of the output active video area with respect to the input.

4.2.4.2.2 Standard Value. The maximum shift for any of the 4 markers shall be y lines, x usec.

4.2.4.2.3 Method of Measurement. Using the test signal of section 4.2.4.1.3, measure the locations (line, usecs) of each of the 4 markers at the output of the transmission service channel. Compute the absolute value of the shift for each of the 4 markers by comparing the output marker locations to the input marker locations.

4.3 Audio Signal Electrical Interface Specifications.

4.3.1 Balanced Audio Specifications. (The analog audio input to and output from the transmission service channel shall be balanced with respect to ground).

4.3.1.1 Input Common Mode Rejection Ratio (CMMR).

4.3.1.1.1 Definition. Input common mode rejection ratio indicates the degree to which unwanted signals coupled into both sides of a balanced line are rejected by the input of the transmission service channel.

4.3.1.1.2 Standard Value. The common mode rejection ratio for all audio input channels to the transmission service channel shall be greater than x dB within

the respective service bandpass and at least y dB at 60 Hz. This specification must be met for common voltages up to x volts rms.

4.3.1.1.3 Method of Measurement. The audio input to the transmission service channel is connected to a center-taped 600 ohm resistive termination. A common mode test signal with voltage V_c is applied between the center tap and ground. The voltage of the resulting signal at the differential output of the transmission service channel is then measured (V_o). The common mode rejection ratio is given by:

$$CMRR = 20 \cdot \log_{10} \left(\frac{V_c}{V_o} \right)$$

4.3.1.2 Output Common Mode Noise.

4.3.1.2.1 Definition. In a balanced audio system, any voltage that is common to both signal leads (measured with respect to ground) is common mode noise.

4.3.1.2.2 Standard Value. The common mode noise of all audio outputs from the transmission service channel shall be at least x dB below nominal operating level.

4.3.1.2.3 Method of Measurement. The audio output is terminated with a center-tapped 600 ohm load. The common mode noise is the voltage measured between the center tap of the 600 ohm load and ground.

4.3.2 Impedance.

4.3.2.1 Source Impedance.

4.3.2.1.1 Definition. The audio source impedance of a transmission service channel, Z_s , shown in Figure 6, is the impedance presented to the input terminals of a transmission service channel by the output terminals of the signal source. Proper source impedance is required for transmission service channel evaluation.

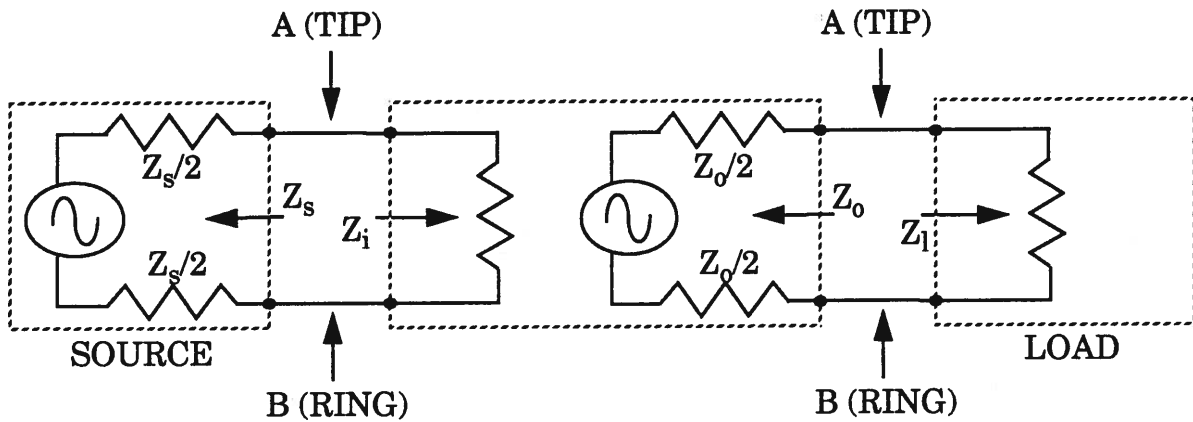

Figure 6 Impedance Reference - Balanced to Ground - Audio

4.3.2.1.2 Standard Value. The standard value shall be 600 ohms, nominally resistive, highly longitudinally balanced, and with a return loss of at least x dB over the frequency range of the respective service bandpass.

4.3.2.1.3 Method of Measurement. The impedance is measured by using impedance measurement equipment and the return loss is reported in dB using the following formula:

$$\text{Return Loss} = 20 \cdot \log_{10} \left| \frac{Z + Z_m}{Z - Z_m} \right|$$

Where

Z = specified standard impedance

Z_m = measured impedance

Alternately, the return loss may be measured using a return loss bridge.

4.3.2.2 Input Impedance.

4.3.2.2.1 Definition. The input impedance of a transmission service channel Z_i shown in Figure 6, is the impedance presented by the input terminals of a transmission service channel.

4.3.2.2.2 Standard Value. The standard value is 600 ohms, nominally resistive, highly longitudinally balanced, and with a return loss of at least x dB over the frequency range of the respective service bandpass.

4.3.2.2.3 Method of Measurement. See section 4.3.2.1.3 on page 13.

4.3.2.3 Output Impedance.

4.3.2.3.1 Definition. The output impedance of a transmission service channel, Z_o shown in Figure 6, is the impedance presented by the output terminals of a transmission service channel.

4.3.2.3.2 Standard Value. The standard value is 600 ohms, nominally resistive, highly longitudinally balanced, and with a return loss of at least x dB over the frequency range of the respective service bandpass.

4.3.2.3.3 Method of Measurement. See section 4.3.2.1.3 on page 13.

4.3.2.4 Load Impedance.

4.3.2.4.1 Definition. The load impedance of a transmission service channel, Z_l shown in Figure 6, is the impedance presented by the input terminals of the device which will terminate the audio output of the transmission service channel. Proper load impedance is required for channel evaluation.

4.3.2.4.2 Standard Value. The standard value is 600 ohms, nominally resistive, highly longitudinally balanced, and with a return loss of at least x dB over the frequency range of the respective service bandpass.

4.3.2.4.3 Method of Measurement. See section 4.3.2.1.3 on page 13.

4.4 Audio Signal.

4.4.1 Input Signal.

4.4.1.1 Input Signal Level.

4.4.1.1.1 Definition. The input signal level to a transmission service channel is the signal level across the transmission service channel input impedance. When the signal is sinusoidal the input signal level is expressed in dBm.

4.4.1.1.2 Standard Value. The peak operating level of the input signal to the transmission service channel across the standard impedance is equal to the peaks of a sine-wave whose average power is 0 dBm. The nominal level is -16 dBm, and the minimum clip level is +9 dBm.

NOTE:

- A. Clip level is defined as the level at which the total distortion exceeds 1%.
- B. This 9 dBm level is only to be applied at the end users interface for program audio services as described in this document. This level is only used for an out-of-service test.

4.4.1.1.3 Method of Measurement. The audio input signal level is measured by properly terminated audio test equipment.

4.4.1.2 Non-Useful DC Component.

4.4.1.2.1 Definition. The non-useful DC component of the audio signal is any DC component which is unrelated to the audio signal and is also present when the audio signal is muted.

4.4.1.2.2 Loop Requirements. When the audio signal is muted, direct current flow shall be equal to or less than x mA through a zero ohm termination across the audio source output terminals.

4.4.1.2.3 Longitudinal Requirements. Direct current flow shall be equal to or less than x mA when the terminals are shorted together and the current flow is measured through a zero impedance to ground.

4.4.2 Output Signal.

4.4.2.1 Output Signal Level.

4.4.2.1.1 Definition. The output signal level of a transmission service channel is the signal level across the transmission service channel output impedance.

4.4.2.1.2 Standard Value. When a 1 KHz test tone at the nominal operating level of -16 dBm is applied to the input of the transmission service channel, the output level shall be -16 dBm plus or minus x dB.

4.4.2.1.3 Method of Measurement. See section 4.4.1.1.3 on page 14.

4.4.2.2 Non-Useful DC Component.

4.4.2.2.1 Definition. The non-useful DC component of the audio signal is any DC component which is unrelated to the audio signal and is also present when the audio signal is muted.

4.4.2.2.2 Loop Requirements. When the audio signal is muted, direct current flow shall be equal to or less than x mA through a zero ohm termination across the transmission service channel output terminals.

4.4.2.2.3 Longitudinal Requirements. Direct current flow shall be equal to or less than x mA when the terminals are shorted together and the current flow is measured through a zero impedance to ground.

4.4.3 Input to Output Audio Relationships.

4.4.3.1 Signal Polarity.

4.4.3.1.1 Definition. The polarity of the signal is the polarity sense of a nonsymmetrical audio transient signal on the A (tip) terminal with respect to the B (ring) terminal of the balanced pair (see Figure 6 on page 12).

4.4.3.1.2 Standard Value. The polarity sense of the audio signal at the output of the transmission service channel shall be the same as that at the input of the transmission service channel.

4.4.3.1.3 Method of Measurement. A nominal 400-Hz clipped sine wave (1/2 wave rectified, see Figure 7) is fed into the input of the transmission service channel. An oscilloscope of a known deflection is used at both ends of the transmission service channel to determine the polarity sense of the audio signal.



Figure 7 Nonsymmetrical Test Waveform - Audio

5 Out-of-Service Baseband VTC/VT Performance Specification.

This out-of-service VTC/VT performance specification gives the average performance of the transmission service channel for a representative group of VTC/VT video and audio signals. The user is cautioned that the performance for a particular input signal may vary from the average performance presented here. If the performance for a particular input signal is desired, the user of this standard should refer to section 6 on page 20. The block diagram for out-of-service testing is shown in Figure 8. As shown in the figure, a test signal and/or test scene generator is connected to the input of the transmission service channel. The test generator provides a source of known audio and video signals for testing the transmission service channel. Parameter measurement equipment is connected to the output of the transmission service channel. The provision is made for sending telemetric data from the test generator to the parameter measurement equipment. The exact requirements for the telemetric data have yet to be determined (the requirements may be as simple as a begin test command). Several options for transmitting the telemetric data include a separate data channel, and the use of the vertical blanking interval of the video signal (if transmitted by the transmission service channel). If the input and the output of the transmission service channel are co-located and non-automated testing is acceptable, then the telemetric data path may be unnecessary for some measurements. The parameter measurement equipment shown in Figure 8 determines the performance parameter values in this standard. Then, these parameter values are inserted into a set of performance calculations to obtain video and audio performance ratings for the transmission service channel. The final performance ratings may then be (optionally) transmitted back to the input of the transmission service channel.

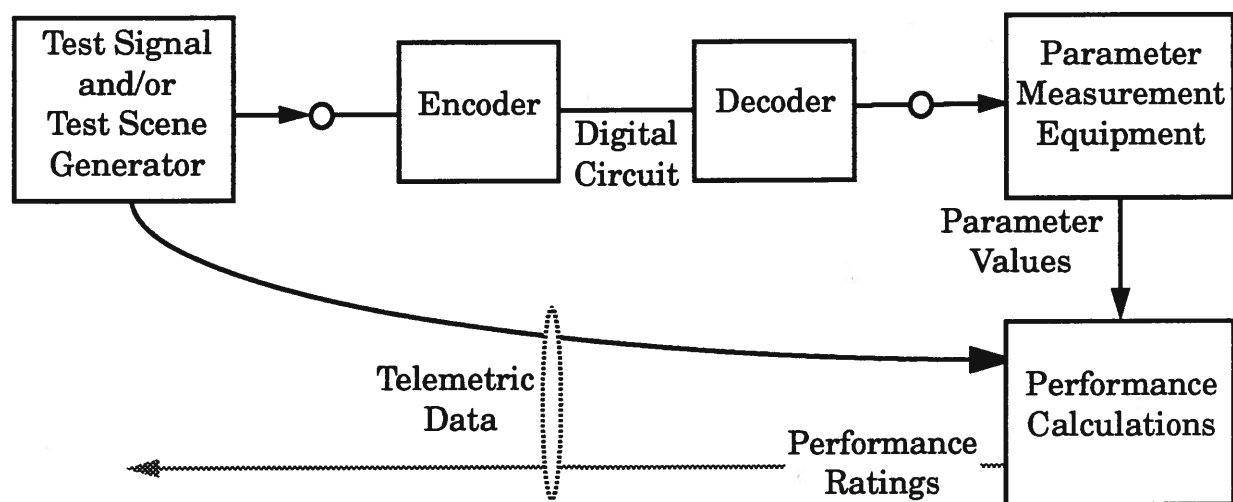

Figure 8 Out-of-Service Testing Block Diagram

5.1 Video Performance.

The video performance has been divided into two major areas; spatial

performance and temporal performance. Spatial performance, a measure of the ability of a video transmission system to accurately reproduce still scenes, is a primary concern for graphical or spatial applications (see definition on page 3). Temporal performance, a measure of the ability of a video transmission system to accurately reproduce moving scenes, is a primary concern for temporal applications (see definition on page 3). A set of performance parameters for quantifying the spatial performance of a transmission service channel is given in section 5.1.1. The overall spatial performance rating for the transmission service channel is then obtained by inserting these parameter values into the algorithm given in section 5.1.2. A set of performance parameters for quantifying the temporal performance of a transmission service channel is given in section 5.1.3. The overall temporal performance rating for the transmission service channel is then obtained by inserting these parameter values into the algorithm given in section 5.1.4. The video performance application table in section 5.1.5 on page 18 can be used to specify the required spatial and temporal performance of the transmission service channel for a number of purposes (e.g., videophone, videoconference, etc.) and subject material (e.g., talking head, graphics, etc.).

5.1.1 Spatial Performance Measures. (This is the place to insert the useful traditional analog parameters as well as newer digital parameters that measure spatial distortions).

5.1.1.1 Parameter Name.

5.1.1.1.1 Definition.

5.1.1.1.2 Method of Measurement.

5.1.2 Spatial Performance Calculation. To compute the overall spatial performance rating for the transmission service channel (O_s), the measured parameter values in section 5.1.1 are inserted into the following equation: (This equation has been included as an example algorithm only)

$$O_s = \sum_{i=1}^N (c_i \cdot p_i) + c_0$$

Where p_i is the value of spatial parameter i , N is the total number of spatial parameters, and c_i (for $i=0$ to N) are constants determined according to the methods specified in Appendix A (i.e., the spatial performance equation shall accurately predict the subjective quality of spatial test scenes).

5.1.3 Temporal Performance Measures. (This is the place to insert the newer digital parameters that measure motion artifacts and temporal distortions).

5.1.3.1 Parameter Name.

5.1.3.1.1 Definition.

5.1.3.1.2 Method of Measurement.

5.1.4 Temporal Performance Calculation. To obtain the overall temporal performance rating for the transmission service channel (O_t), the measured parameter values in section 5.1.3 are inserted into the following equation: (This equation has been included as an example algorithm only)

$$O_t = \sum_{i=1}^N (c_i \cdot p_i) + c_0$$

Where p_i is the value of temporal parameter i , N is the total number of temporal parameters, and c_i (for $i=0$ to N) are constants determined according to the methods specified in Appendix A (i.e., the temporal performance equation shall accurately predict the subjective quality of temporal test scenes).

5.1.5 Video Performance Application Table. This table is provided as a guide to assist end-users and service-providers in specifying spatial and temporal performance levels. The spatial performance calculation (from section 5.1.2 on page 17) and the temporal performance calculation (from section 5.1.4 on page 18) are utilized as shown in Table 1. In the table, spatial performance increases as one moves from left to right and temporal performance increases as one moves down. The recommended spatial and temporal performance levels for various purposes (e.g., videophone, videoconference, etc.) and subject material (e.g., talking head, graphics, etc.) are shown.

		Spatial Performance			
		Level 1 ($O_s > x_1$)	Level 2 ($O_s > x_2$)	Level 3 ($O_s > x_3$)	Level 4 ($O_s > x_4$)
Temporal Performance	Level 1 ($O_t > y_1$)			Videophone (graphics)	
	Level 2 ($O_t > y_2$)	Videophone (talking head)	Videoconference (people)	Videoconference (people + graphics)	
	Level 3 ($O_t > y_3$)		VCR (varied)	Distribution (training, education)	Contribution (TV studio)

Table 1 Video Performance Specifications for Several Applications

5.2 Audio Performance.

A set of performance parameters for quantifying the audio performance of a transmission service channel is given in section 5.2.1. The overall audio performance rating for the transmission service channel is then obtained by inserting these parameter values into the algorithm given in section 5.2.2. The audio performance application table in section 5.2.3 on page 19 can be used to specify the required audio performance of the transmission service channel for a number of purposes (e.g., videophone, videoconference, etc.).

5.2.1 Audio Performance Measures. (This is the place to insert the useful traditional audio parameters as well as newer digital parameters that measure audio distortions, such as those being considered by the CCITT).

5.2.1.1 Parameter Name.

5.2.1.1.1 Definition.

5.2.1.1.2 Method of Measurement.

5.2.2 Audio Performance Calculation. To obtain the overall audio performance rating for the transmission service channel (O_a), the measured parameter values in section 5.2.1 are inserted into the following equation: (This equation has been included as an example algorithm only)

$$O_a = \sum_{i=1}^N (c_i \cdot p_i) + c_0$$

Where p_i is the value of audio parameter i , N is the total number of audio parameters, and c_i (for $i=0$ to N) are constants determined according to methods similar to those specified in Appendix A (i.e., the audio performance equation shall accurately predict the subjective quality of audio signals).

5.2.3 Audio Performance Application Table. This table is provided as a guide to assist end-users and service-providers in specifying audio performance levels. The audio performance calculation (from section 5.2.2 on page 19) is utilized as shown in Table 2. In the table, audio performance increases as one moves from left to right. The recommended audio performance level for various purposes (e.g., videophone, videoconference, etc.) is shown.

Audio Performance			
Level 1 ($O_a > x_1$)	Level 2 ($O_a > x_2$)	Level 3 ($O_a > x_3$)	Level 4 ($O_a > x_4$)
Videophone	Videoconference	VCR, Distribution	Contribution

Table 2 Audio Performance Specifications for Several Applications

5.3 Audio-Visual Performance Measures.

Audio-visual performance measures quantify important attributes of the audio-visual signal. These performance measures fall into one of two categories: (1) parameters that quantify important attributes of both the audio signal and the video signal (2) parameters that quantify the interactions between the audio signal and the video signal, and hence require both the audio signal and the video signal for proper measurement.

5.3.1 Overall Path Delay.

5.3.1.1 Definition. Overall path delay is the greater of the one-way transmission delay of the audio signal, and the one-way transmission delay of the video signal, when only lips and eyes of the talking user (talking head) are moving.

5.3.1.2 Standard Value. (Under Study)

5.3.1.3 Method of Measurement. (Under Study)

5.3.2 Audio-Visual Synchronization.

5.3.2.1 Definition. Audio-visual synchronization is the difference between the one-way transmission delays of the audio signal and the video signal when only lips and eyes of the talking user (talking head) are moving.

5.3.2.2 Standard Value. (Under Study)

5.3.2.3 Method of Measurement. (Under Study)

6 In-Service Baseband VTC/VT Performance Specification.

In general, the performance of the transmission service channel depends upon

the information content of the input video and audio signals. This in-service VTC/VT performance specification provides a non-intrusive method for measuring the performance of the transmission service channel for any input signal. The block diagram for in-service testing is shown in Figure 8. As shown in the figure, parameter measurement equipment is connected to both the input and output of the transmission service channel. The parameter measurement equipment is connected in a non-intrusive manner so that the video and audio performance of the transmission service channel are not effected. The provision is made for sending telemetric data from the parameter measurement equipment at the input to the parameter measurement equipment at the output. The exact requirements for the telemetric data have yet to be determined but will likely consist of extracted parameter values from the input signal. Several options for transmitting the telemetric data include a separate data channel, and the use of the vertical blanking interval of the video signal (if transmitted by the transmission service channel). The parameter measurement equipment determines the performance parameter values in this standard. Then, these parameter values are inserted into a set of performance calculations to obtain video and audio performance ratings for the transmission service channel. The final performance ratings may then be (optionally) transmitted back to the input of the transmission service channel. Performance ratings are calculated for each x second time interval of the transmission.

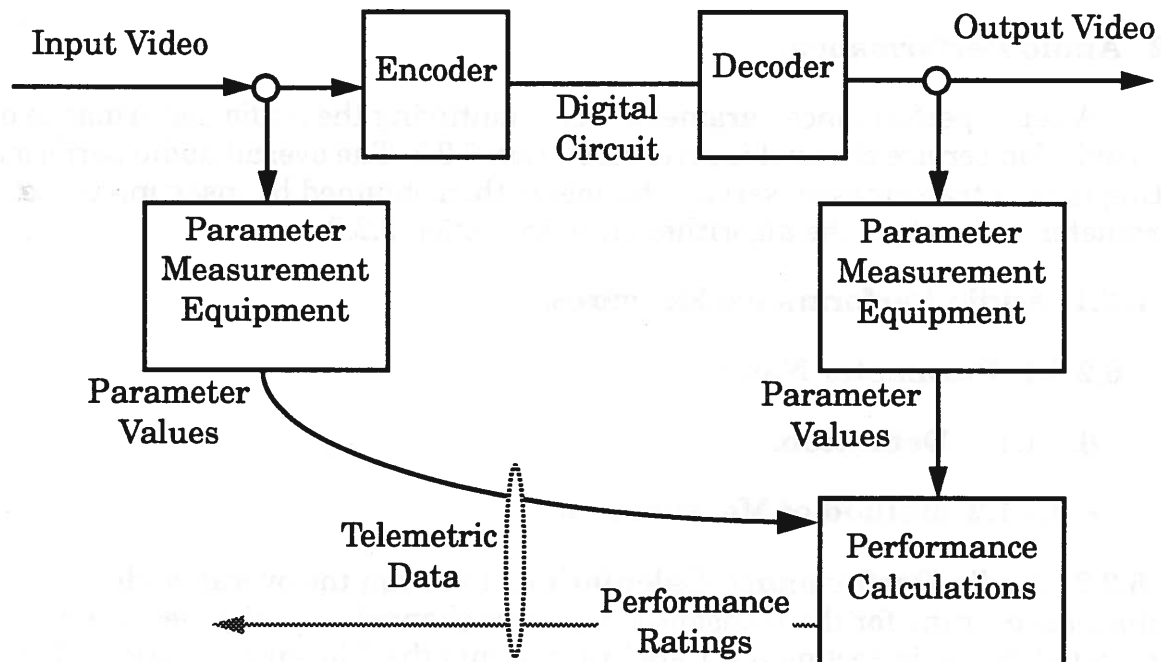

Figure 9 In-Service Testing Block Diagram

6.1 Video Performance.

A set of performance parameters for quantifying the video performance of a

transmission service channel is given in section 6.1.1. The overall video performance rating for the transmission service channel is then obtained by inserting these parameter values into the algorithm given in section 6.1.2.

6.1.1 Video Performance Measures.

6.1.1.1 Parameter Name.

6.1.1.1.1 Definition.

6.1.1.1.2 Method of Measurement.

6.1.2 Video Performance Calculation. To compute the overall video performance rating for the transmission service channel (O_v), the measured parameter values in section 6.1.1 are inserted into the following equation: (This equation has been included as an example algorithm only)

$$O_v = \sum_{i=1}^N (c_i \cdot p_i) + c_0$$

Where p_i is the value of video parameter i , N is the total number of video parameters, and c_i (for $i=0$ to N) are constants determined according to the methods specified in Appendix A (i.e., the video performance equation shall accurately predict the subjective quality of video test scenes).

6.2 Audio Performance.

A set of performance parameters for quantifying the audio performance of a transmission service channel is given in section 6.2.1. The overall audio performance rating for the transmission service channel is then obtained by inserting these parameter values into the algorithm given in section 6.2.2.

6.2.1 Audio Performance Measures.

6.2.1.1 Parameter Name.

6.2.1.1.1 Definition.

6.2.1.1.2 Method of Measurement.

6.2.2 Audio Performance Calculation. To obtain the overall audio performance rating for the transmission service channel (O_a), the measured parameter values in section 5.2.1 are inserted into the following equation: (This equation has been included as an example algorithm only)

$$O_a = \sum_{i=1}^N (c_i \cdot p_i) + c_0$$

Where p_i is the value of audio parameter i , N is the total number of audio parameters, and c_i (for $i=0$ to N) are constants determined according to methods similar to those

specified in Appendix A (i.e., the audio performance equation shall accurately predict the subjective quality of audio signals).

6.3 Audio-Visual Performance Measures.

6.3.1 Availability of Service. (Under Study)

Appendix

Appendix A

Methodology Used for Evaluating Out-of-Service Performance Measures

The information in this appendix provides a historical record of the approach and the actual test results that were used to select the objective performance measures in this standard. The detailed methodology presented here can be used by others to verify the validity of this standard as well as to expand upon the standard so that it will be useful for measuring the performance of future, as of now unspecified, audio-visual services. This appendix describes the methodology used for developing the video performance measures. Extension of this methodology to include the audio performance measures should be straightforward. The extended methodology should consider the possibility of interactions between the audio performance and the video performance.

Overview of Approach. An overview of the approach that is used to develop and evaluate the objective quality estimators is shown in Figure A1 on page 26. A primary design goal for objective quality estimators is an output that accurately predicts the overall quality score as perceived by the end-user. Thus, subjective test results form a key criterion for the evaluation of acceptable objective quality estimators. The test scenes used for the subjective tests are divided into two groups; spatial test scenes (s_1, s_2, \dots, s_m), and temporal test scenes (t_1, t_2, \dots, t_n). The spatial test scenes are chosen to test the spatial performance of the digital transmission service channel under test (DUT), while the temporal test scenes are chosen to test the temporal performance of the DUT. These subjective test scenes are input into a set of representative DUTs and the resulting output scenes are subjectively judged by viewing panels. Subjective impairment scores for these test scenes are then combined with the subjective combiners to produce two composite subjective scores for each DUT; a composite subjective score for the set of spatial test scenes (S_s), and a composite subjective score for the set of temporal scenes (S_t). Similarly, the objective test waveforms (w_1, w_2, \dots, w_j) are also input into the DUTs and the proposed objective quality estimators (1 through k) each measure a set of objective parameters and produce objective quality estimates of the spatial performance ($O_{s1}, O_{s2}, \dots, O_{sk}$) and temporal performance ($O_{t1}, O_{t2}, \dots, O_{tk}$) of the DUT. The criterion for determining the accuracy of the objective quality estimates is minimization of the squared error differences between the objective and subjective estimates of performance averaged over all DUTs. These squared error differences are denoted by E_s^2 and E_t^2 in Figure A1, where E_s is the error in the spatial performance estimate and E_t is the error in the temporal performance estimate for a DUT. All of the outputs from the objective quality estimators can themselves be combined by an objective combiner. The final composite objective estimates from the objective combiner may provide improved estimates of the spatial performance (O_s) and temporal performance (O_t) of the DUT. This approach allows different organizations to independently develop objective

quality estimators and enables the integration of the various methods into a coherent standard.

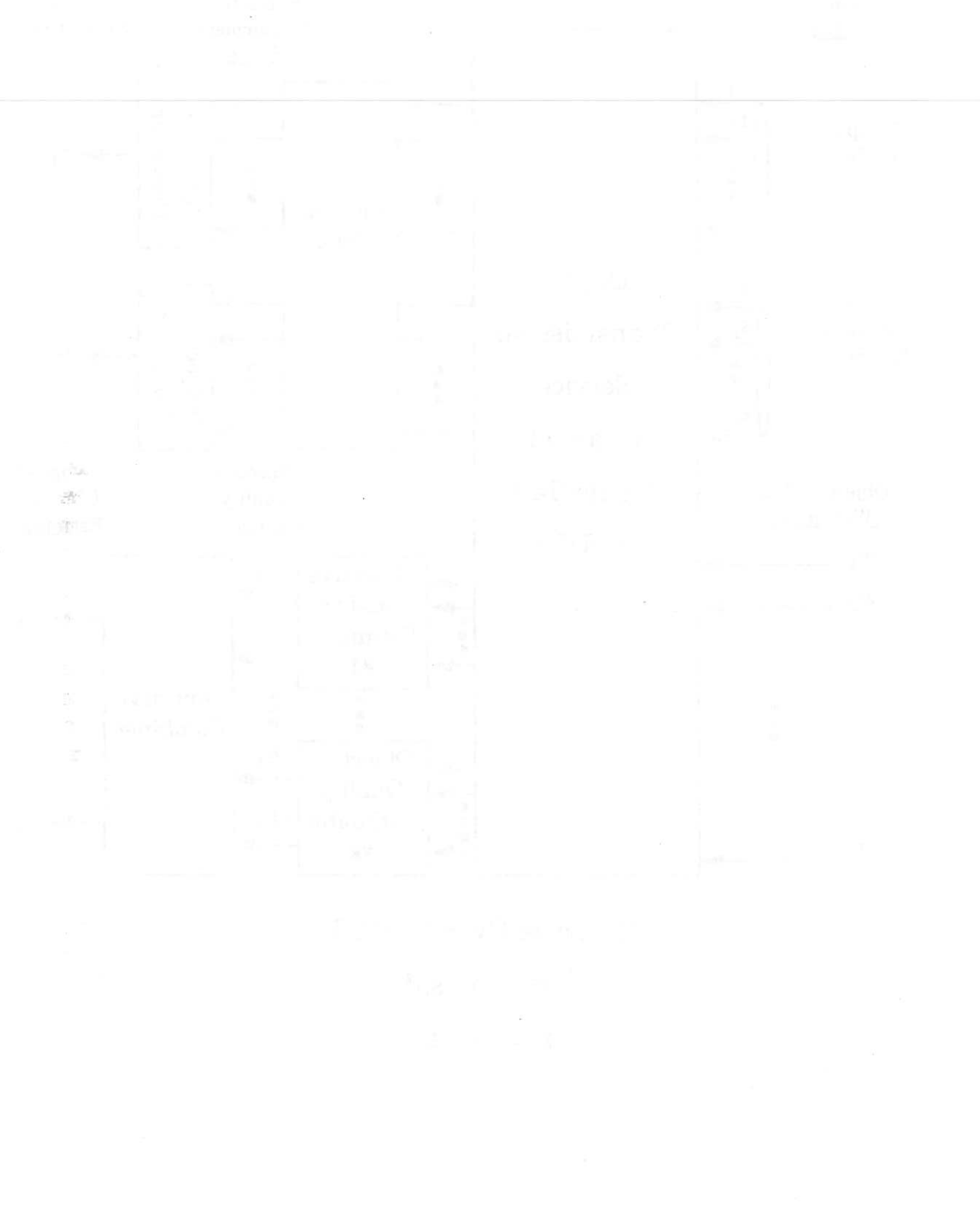

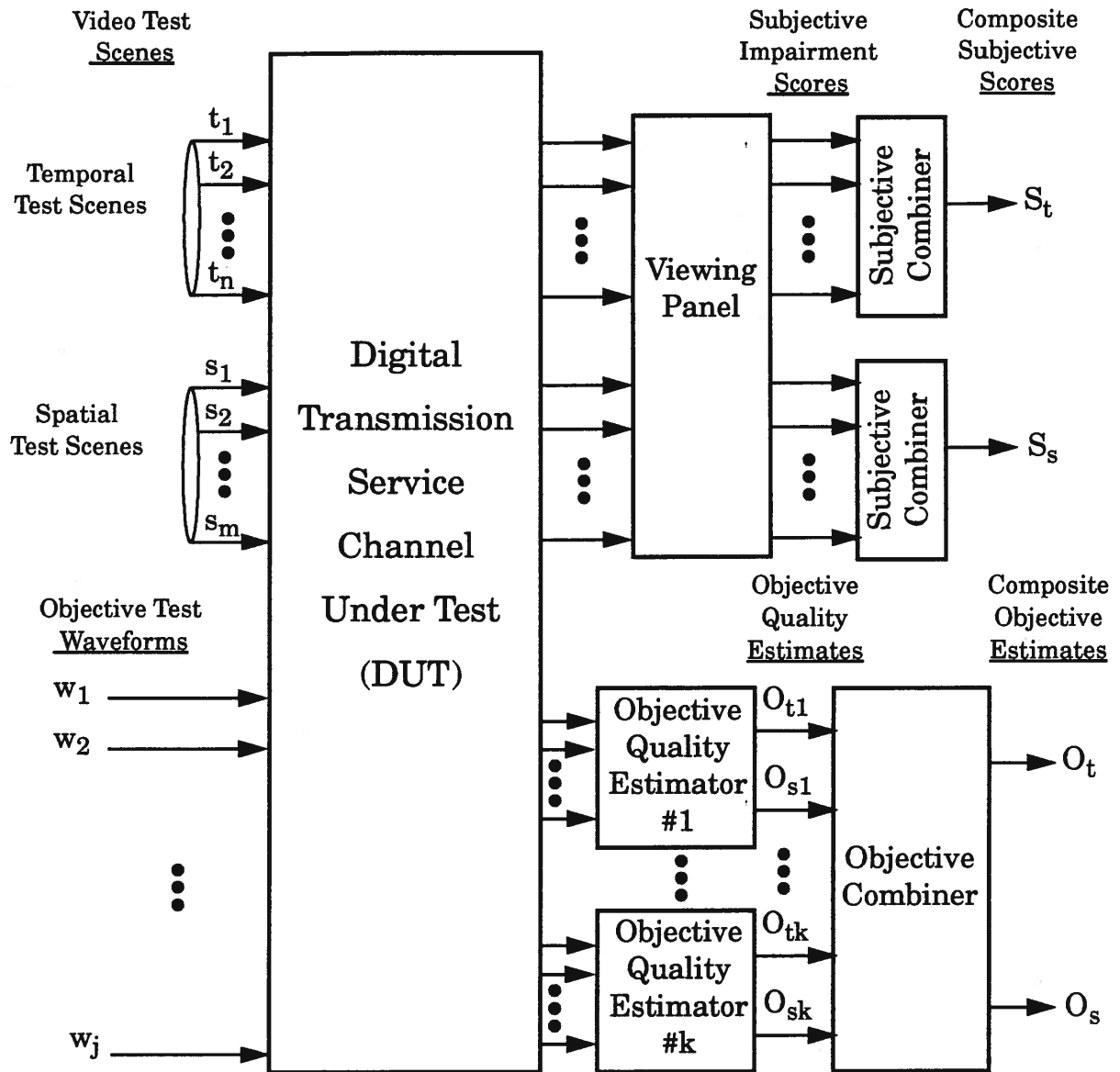

Minimize Over All DUTs

$$E_t^2 = (O_t - S_t)^2$$

$$E_s^2 = (O_s - S_s)^2$$

Figure A1 Approach Used To Evaluate Objective Quality Estimation Methods

Test Scene Selection. The selection of test scenes is a very important issue. In particular, the spatial and temporal information content of the scenes are critical parameters. These parameters play a crucial role in determining the amount of video compression that is possible, and consequently, the level of impairment that is suffered when the scene is transmitted over a fixed-rate digital transmission service channel. Figure A2 shows the relative amounts of spatial and temporal information for some possible test scenes. Fair and relevant video test scenes must be chosen such that their spatial and temporal information content is consistent with the video services that the digital transmission service channel was intended to provide. As shown in Figure A1 on page 26, two groups of test scenes are proposed; spatial test scenes to test the spatial performance, and temporal test scenes to test the temporal performance. The set of test scenes should span the full range of spatial and temporal information content of interest to users of this standard. The specific set of video scenes to use for testing should be agreed upon by the VTC/VT sub-working group as soon as possible.

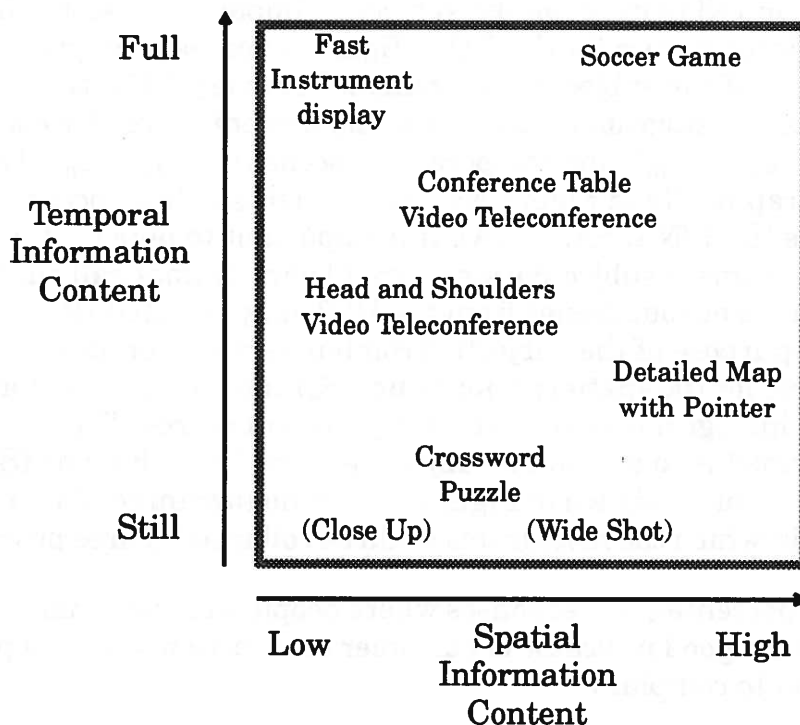

Figure A2 Information Content of Test Scenes

DUT Selection. The objective performance measures and algorithms set forth in this standard should be tested using a representative set of DUTs that include all relevant technologies for which this standard applies. Preferably, the pool of DUTs should be sufficiently large to test the technology independence (i.e., not dependent on the coding algorithm or transport architecture) of the objective quality estimators. Thus, selection of a DUT involves not only selection of the digital codec and bit rate,

but also selection of the transport mechanism. The specific set of DUTs to use for testing should be agreed upon by the VTC/VT sub-working group as soon as possible.

Subjective Viewing Tests. The subjective viewing tests should be conducted in accordance with CCIR Recommendation 500. The 5-point impairment scale given in Recommendation 500 is useful when comparison of subjective results between laboratories is desired, and when the range of impairments will vary considerably. The subject is first presented with a scene and then with an impaired version of the same scene. The subjects are instructed to decide on and mark the level of impairment in the second scene, using the first scene as a reference. The five possible responses are: Imperceptible (IP), Perceptible but Not Annoying (P/NA), Slightly Annoying (SA), Annoying (A), and Very Annoying (VA). This 5-point impairment scale intentionally covers a very wide range of impairment levels in a non-linear fashion. By including reference scenes, impairment tests take advantage of the fact that the human eye excels at making comparisons.

Subjective Combiners. The subjective combiners shown in Figure A1 on page 26 are required to combine the subjective impairment scores into an overall composite subjective score for the DUT. Figure A3 on page 30 gives a block diagram for the functions of the subjective combiners. For every DUT, the subjective test results produce a histogram of subjective impairment scores for each of the spatial test scenes (s_1, s_2, \dots, s_m), and temporal test scenes (t_1, t_2, \dots, t_n). These histograms are depicted graphically in Figure A3 by the heights of lines occurring in each of the histogram bins (IP, P/NA, SA, A, VA). It is important to note that, even for a fixed DUT, the histograms of subjective scores could vary dramatically depending upon the scene input. Some output scenes from the DUT may be rated IP while others may be rated VA. The purpose of the subjective combiners are to produce overall composite subjective scores for the spatial performance (S_s) and temporal performance (S_t) of the DUT from the histograms of subjective impairment scores. The first function that must be performed is to produce a subjective score for each scene ($S_{s1}, S_{s2}, \dots, S_{sm}, S_{t1}, S_{t2}, \dots, S_{tn}$). This is shown in Figure A3 as a histogram combiner. There are many possible ways in which the histograms could be collapsed. Three possible methods are:

1. The total percentage of responses where people were not annoyed ($\%IP + \%P/NA$). This might be a good indicator of customer satisfaction since people that are annoyed tend to complain.
2. The total percentage of responses where people do not see an impairment ($\%IP$). This might be a good indicator of high quality video and hence might be useful for people that desire contribution quality video.
3. The weighted sum where each type of response is multiplied by a unique weight ($\text{weight}_1(\%VA) + \text{weight}_2(\%A) + \text{weight}_3(\%SA) + \text{weight}_4(\%P/NA) + \text{weight}_5(\%IP)$). Here, the weight could vary in relationship to the importance of the particular histogram bin. A linear mean opinion score (MOS) can be generated from this equation if the weights are 1, 2, 3, 4, 5, respectively.

Next, the scene combiner shown in Figure A3 takes the subjective scores for each scene, as output by the histogram combiner ($S_{s1}, S_{s2}, \dots, S_{sm}, S_{t1}, S_{t2}, \dots, S_{tn}$), and produces the composite subjective scores for the spatial performance (S_s) and temporal performance (S_t) of the DUT. Once again, there are several possible methods to collapse the individual scene scores into overall composite scores for the DUT. Two possible methods are:

1. Assign equal weight (or importance) to each scene. Here, each spatial scene would have a weight of $1/m$, and each temporal scene would have a weight of $1/n$.
2. Assign zero weights to some of the test scenes depending upon the specific application as given in Table 1 on page 18. Then, assign equal weights to the remaining test scenes such that the sum of all spatial test scene weights is equal to one and the sum of all temporal test scene weights is equal to one. This method would allow the flexibility of tailoring the performance measurements to each of the applications given in Table 1 on page 18 (i.e., videophone - talking head, videophone - graphics, videoconference - people, etc.).

The specific subjective combiners should be agreed upon by the VTC/VT sub-working group as soon as possible.

Histograms of Subjective Scores for a DUT

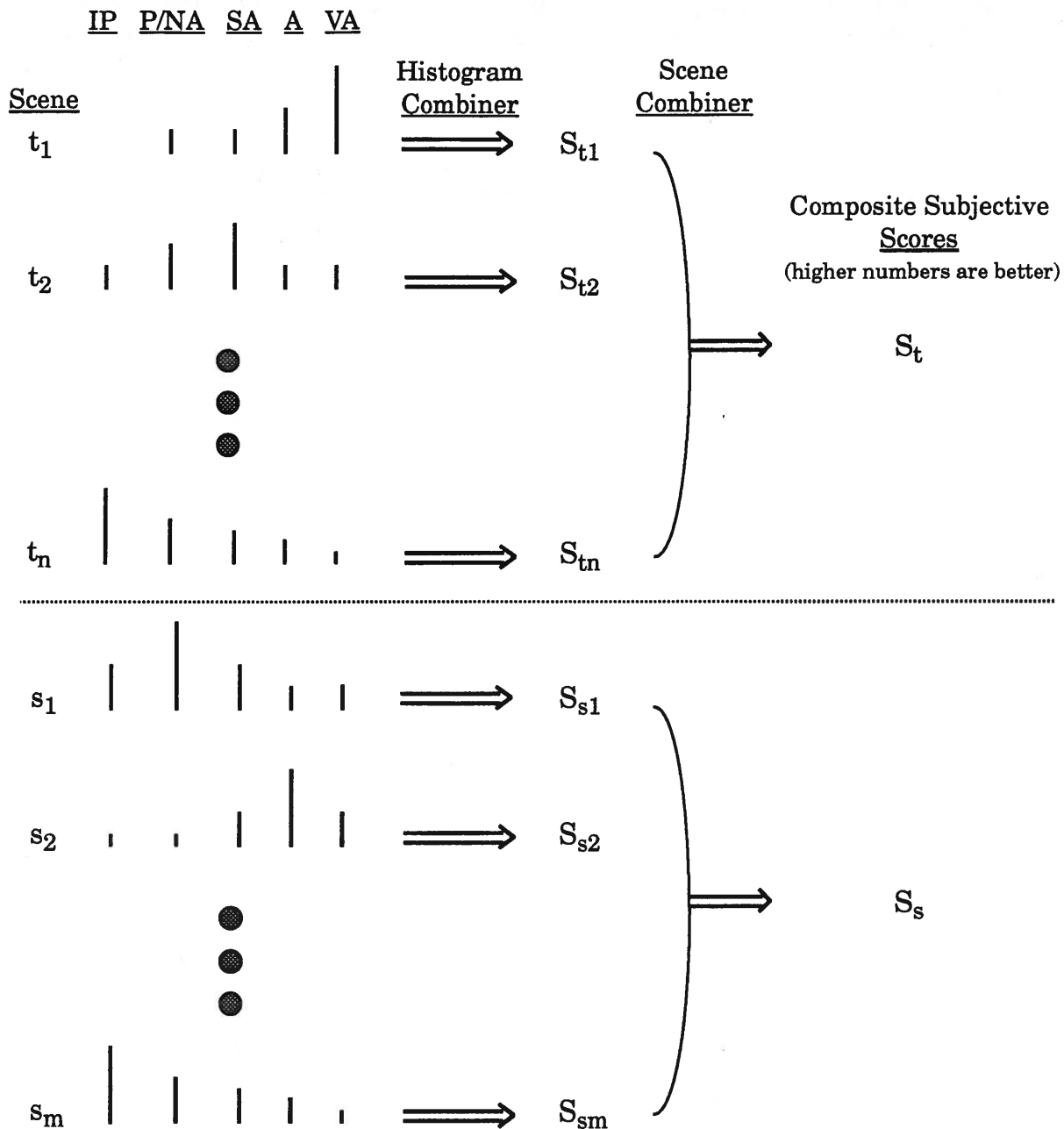

Figure A3 Block Diagram of Subjective Combiners

Objective Test Waveforms. The objective test waveforms (w_1, w_2, \dots, w_j) shown in Figure A1 on page 26 are analog video waveforms and include waveforms that are required to measure the traditional analog parameters as well as those that are required to measure any new objective parameters. After passing through the DUT, the output analog test waveforms are input into the proposed objective quality estimators (1 through k). Normally, a subset of the total waveforms will be utilized by each of the proposed objective quality estimators since some waveforms may have been specifically designed to work in conjunction with certain estimators.

Objective Quality Estimators. The proposed objective quality estimators (1 through k) shown in Figure A1 on page 26 each extract a set of objective performance parameters from the objective test waveforms, and combine these objective parameters to produce estimates of the spatial performance ($O_{s1}, O_{s2}, \dots, O_{sk}$) and temporal performance ($O_{t1}, O_{t2}, \dots, O_{tk}$) of the DUT. The designer of the objective quality estimator is free to choose the algorithm that produces quality estimates from the objective parameters. However, the criterion for determining the accuracy of the objective quality estimates is minimization of the averaged squared error difference between the objective and subjective estimates of performance over all DUTs. These squared error differences are denoted by E_s^2 and E_t^2 in Figure A1, where E_s is the error in the spatial performance estimate and E_t is the error in the temporal performance estimate for a DUT.

Objective Combiner. The objective combiner enables integration of the k objective quality estimates that are produced by the objective quality estimators. Composite estimates of spatial and temporal performance (O_s and O_t in Figure A1 on page 26) are produced by the objective combiner. The composite estimates will be at least as good as any of the individual estimates produced by the objective quality estimators. One could use linear predictors to predict O_s and O_t from the output of the objective quality estimators ($O_{s1}, O_{s2}, \dots, O_{sk}$) and ($O_{t1}, O_{t2}, \dots, O_{tk}$), respectively. Then, the prediction equations would take the form:

$$O_s = \left(\sum_{i=1}^k (\alpha_i \cdot O_{si}) \right) + C_s$$

for the spatial performance and

$$O_t = \left(\sum_{i=1}^k (\beta_i \cdot O_{ti}) \right) + C_t$$

for the temporal performance, where weights α_i and β_i are chosen such that the squared error differences between the objective and subjective estimates of performance are minimized over all DUTs. Constants C_s and C_t have been included to allow for the possibility that some of the individual estimates produced by the objective quality estimators are biased. One can look at the value of the individual weights α_i and β_i to determine if an objective quality estimator is not contributing to the overall composite score (the weights for that estimator will be small). In this case, the non-contributing estimator can be discarded without losing accuracy.

Test Results. This section presents detailed test results for the objective

quality measurement system used in this standard. The objective quality estimates obtained by use of this standard are compared with actual subjective quality ratings. Close correlation of the objective quality estimates with the subjective scores demonstrates the validity of the objective video quality estimators used in this standard. (Insert results of tests).

Glossary

Exchange Carrier (EC).

The telecommunications common carrier franchised to provide telecommunications services within one or more exchanges. An EC may also provide exchange access service, intra-LATA long-distance service, and in some unusual cases, inter-LATA service.

Interexchange Carrier (IC).

A telecommunications common carrier authorized to provide telecommunications services between LATAs. An IC may also provide service within some LATAs.

Local Access and Transport Area (LATA).

A geographic area established for the provision and administration of telecommunications services. A LATA encompasses one or more exchanges that have been grouped to serve common social, economic, and other purposes.

Network Interface (NI).

The point of demarcation between the carrier's facilities and the customer's installation which establishes the technical interface and division of operational responsibility.

Point of Termination (POT).

The point of demarcation between carriers which establishes the technical interface and division of operational responsibility.

Items Under Study